

Y-Series



KEY ADVANTAGES

- Wattage from 100W to 240W optional
- Power Selectable (Optional)
- High energy savings compared to systems with traditional discharge lamps
- Light-on-demand feature with optional motion sensor
- Robust design
- Emergency lighting with optional battery
- High visual comfort
- No hazardous materials
- Fast ROI thanks to long life span and reduced maintenance
- Compact housing optimised for heat dissipation and reduced dust accumulation
- Dedicated range of mounting accessories

TYPES OF APPLICATION

- CAR PARKS
- LARGE AREAS
- INDUSTRIAL HALLS & WAREHOUSES
- SPORT FACILITIES



CAR PARKS



LARGE AREAS



INDUSTRIAL HALLS & WAREHOUSES



SPORT FACILITIES



GENERAL INFORMATION

Driver included	Yes
CE mark	Yes
RoHS compliant	Yes
Safety features	Open circuit protection Short circuit protection Overvoltage protection
Testing standard	LM-79-19(all measurements in ISO17025 accredited laboratory)

HOUSING AND FINISH

Housing	Aluminium
Optic	Polycarbonate
Protector	Polycarbonate (with integrated lenses)
Housing finish	Electrostatic polyester powder coating
Standard colour(s)	RAL 9017 black
Tightness level	IP 65
Impact resistance	IK 09

OPERATING CONDITIONS

Operating temperature range (Ta)	-30°C to + 45°C
Operating Humidity	10-90%RH
Mounting Option	Loop Hanging Bracket Mounting
Warranty	5 years

PERFORMANCE

Power	100W/150W/200W/240W
Efficacy	190lm/W, 170lm/W, 150lm/W
Power Efficiency	≥93%
Start Time	≤0.2S
Warm-up time to 60%	0.5S

ELECTRICAL INFORMATION

Electrical class	Class I EU
Nominal voltage	120-277V 50/60Hz
Power factor (at full load)	0.9
Surge protection options (kV)	6KV-Line-Line 6KV-Line-Earth
Electromagnetic compatibility (EMC)	EN 55015:2019/A11:2020, EN 61000 3-2:2019, EN 61000-3-3:2013, EN 61547:2009, EN 62493:2015
Control protocol(s)	1-10V, DALI2 (optional)
Emergency	Optional auxiliary battery
Total Harmonic Distortion(THD)	IEC 61000-3-2 Class C <20%
Driver Type	Constant current(CC)
For fixed Class 1 luminaires, overvoltage protective devices which comply with IEC 61643-11 shall be disconnected from the circuit.	
withstand voltage	1.5KV 60S 10mA

※Lamp switch must control L line or control L and N lines.

OPTICAL INFORMATION

LED Type	SMD2835
Beam Angle	60° / 90° / 120°
Recommended installation height	4m to 12m
Color Tolerance	Ra70 ≤7 Ra80 ≤5
LED colour temperature	3000K / 4000K / 5000K / 5700K / 6500K
Colour rendering index (CRI)	CRI>70 standard CRI>80 optional
Upward Light Output Ratio (ULOR)	0%

※Ra measurement tolerance is ±2.

LIFETIME OF THE LEDS @ TA 25°C

All configurations	
L70B50	>100,000h
L80B20	>50,000h
L90B10	>30,000h
Switching Cycles	>100,000 times

PRO VERSION

POWER	LUMENS	EFFICACY
100W	19,000LM	190LM/W(Ra70)
	18,000LM	180LM/W(Ra80)
150W	28,500LM	190LM/W(Ra70)
	27,000LM	180LM/W(Ra80)
200W	38,000LM	190LM/W(Ra70)
	36,000LM	180LM/W(Ra80)
240W	45,600LM	190LM/W(Ra70)
	43,200LM	180LM/W(Ra80)

STANDARD VERSION

POWER	LUMENS	EFFICACY
100W	17,000LM	170LM/W(Ra70)
	15,700LM	157LM/W(Ra80)
150W	25,500LM	170LM/W(Ra70)
	24,000LM	160LM/W(Ra80)
200W	34,000LM	170LM/W(Ra70)
	32,000LM	160LM/W(Ra80)
240W	40,800LM	170LM/W(Ra70)
	38,400LM	160LM/W(Ra80)

ECO VERSION

POWER	LUMENS	EFFICACY
100W	15,000LM	150LM/W(Ra70)
	14,000LM	140LM/W(Ra80)
150W	22,500LM	150LM/W(Ra70)
	21,000LM	140LM/W(Ra80)
200W	30,000LM	150LM/W(Ra70)
	28,000LM	140LM/W(Ra80)
240W	36,000LM	150LM/W(Ra70)
	33,600LM	140LM/W(Ra80)

※The Performance Data is tested base on 230VAC, 90° and 4000K for all versions
 ※Power Consumption Tolerance ±5% (Apply to all versions)
 ※Lumen Efficiency Tolerance ±5% (Apply to all versions)

PACKAGING

POWER	PACKAGE SIZE	QTY/CTN	SINGLE PIECE VOLUME	NET WEIGHT	GROSS WEIGHT	20GP	40HQ
100W	L275*W275*H175mm	1PCS/CTN	0.0132m ³	1.4kg	1.6kg	2301pcs	5841pcs
150W	L310*W310*H180mm	1PCS/CTN	0.0173m ³	1.8kg	1.9kg	1699pcs	4313pcs
200W	L360*W360*H195mm	1PCS/CTN	0.0253m ³	2.5kg	2.8kg	1212pcs	3078pcs
240W	L400*W400*H190mm	1PCS/CTN	0.0304m ³	3.0kg	3.8kg	1111pcs	2565pcs

LIGHT DISTRIBUTIONS

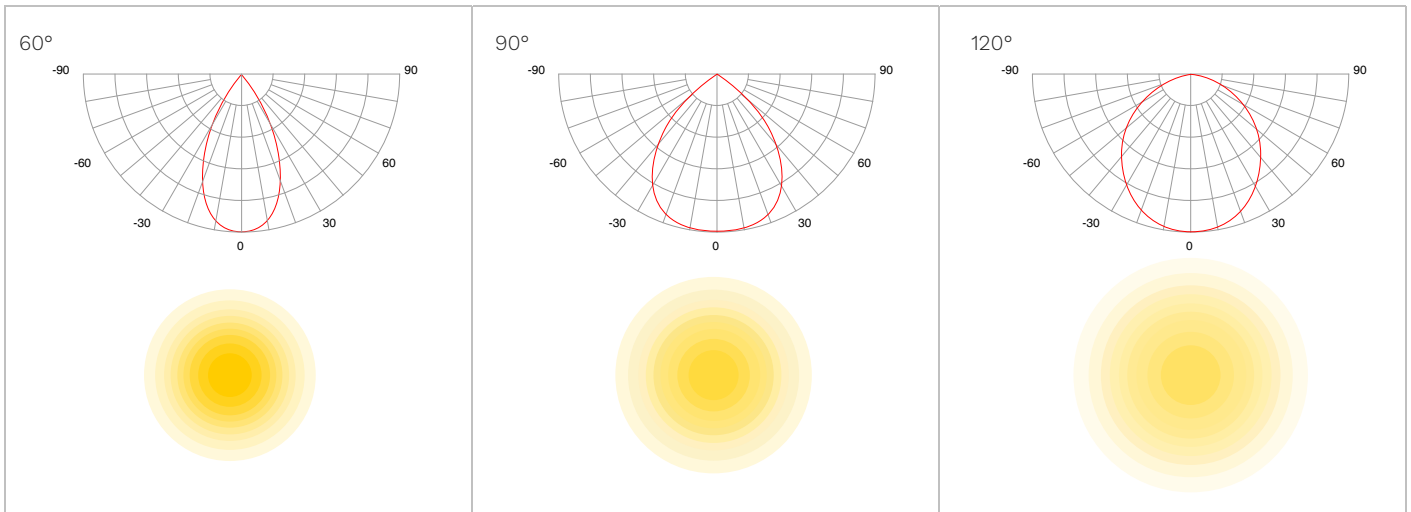

OPTIONAL

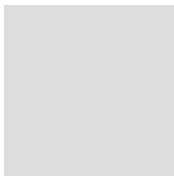
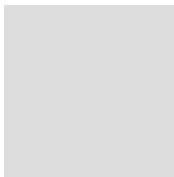

120° Tempered Glass Only 150W 200W 240W is supported.

ACCESSORIES

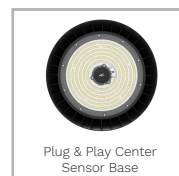
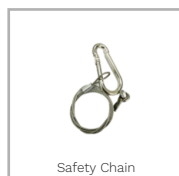
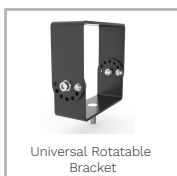
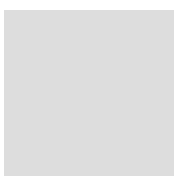
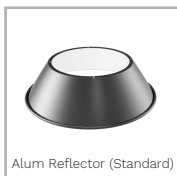
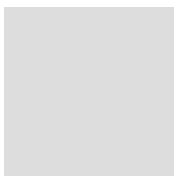

Motion Sensor Only supported 100W/150W/200W

Connecting the cable requires an IP65 Tightness level

100W

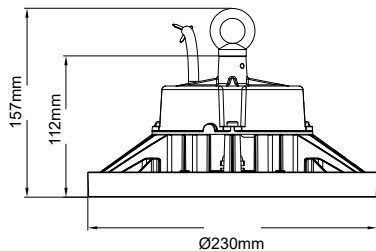

150W

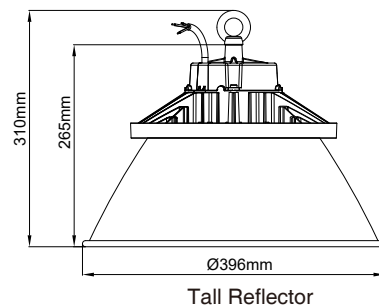
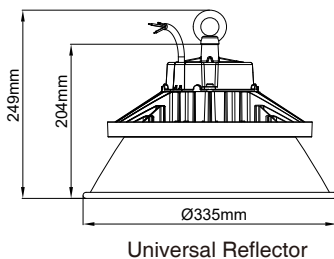
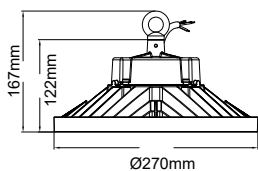

200W

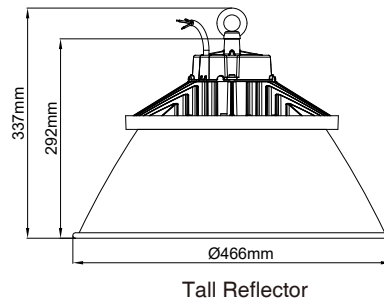
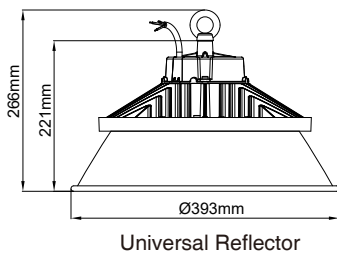
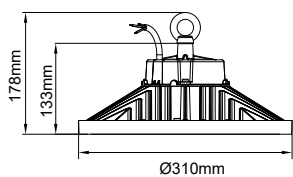

240W

